



Oil separator

Standards | Quality charter | D.O.P | Operation

I | Standards

The production of oil separator complies with European standard EN 858.:

- **EN 858-1**

“Principles of product design, performance and testing, marking and quality control”

- **EN 858-2**

“Separator systems for light liquids (e.g. oil and petrol)” – Part 2: Selection of nominal size, installation, operation and maintenance.”

Scheme of a complete system

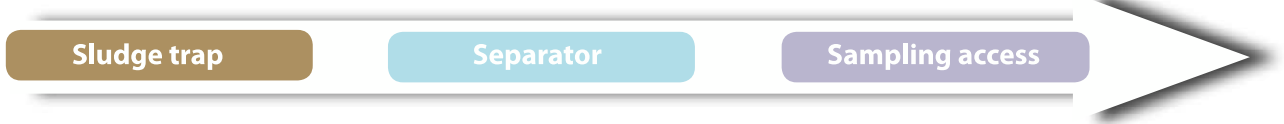

1.1 • The volume of a sludge trap according to the standard

Definition taken from the standard EN 858-1:

“The sludge trap is the part of the separator where material settles i.e. sludge, silt and grit. It can be constructed with the separator as a combined unit”.

“The value retained for the sizing of the sludge trap can vary according to the standard NF EN 858-2. Below the section from paragraph 4.4 and the table to be used to establish this value:”

Quantity of sludge anticipated for e.g.:		Minimum sludge trap volume /
None	- condensate	Not required
Small ¹⁾	- processing waste water with defined small sludge volume - all rainwater collecting areas where a small amount of silt from traffic or similar appears. i.e. catchment basins on petrol tank areas and covered filling stations	$\frac{100 \times NS}{f_d}$
Medium ²⁾	- filling stations, carwash by hand, part washing - bus washing places - waste water from garages, vehicle parking lots - power plants, machinery plants	$\frac{200 \times NS}{f_d}$
High ²⁾	- washing plants for site vehicles, site machines, farm machines - truck wash places - automatic car washes i.e. roll-over, drive-through (minimum sludge trap volume 5000 l)	$\frac{300 \times NS}{f_d}$
<p>1) Not for separators smaller than or equal NS 10, except for covered car parks 2) Minimum volume of sludge traps 600 l.</p>		

1.2 • The volume of a separator according to the standard

On the sole basis of purification effectiveness, the NF EN858-1 standard does not define a minimum volume of the separation chamber: “the separator is the part of the separator system which separates light liquid from waste water and retains light liquid”.

Schematic drawing of an oil separator with an integrated sludge trap

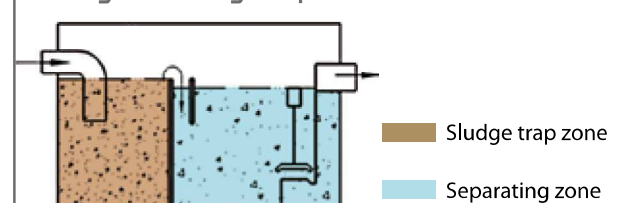

The automatic closure device prevents any accidental discharge of free decanted hydrocarbons into the downstream pipeline.



Oil separator

Standards | Quality charter | D.O.P. | Operation

In order to validate the purification effectiveness of an oil separator, the manufacturer must test it on a **test bench according to the paragraph 8.3.3 from NF EN 858-1 Standard.**

The volume of the sludge trap shall be excluded as shown in the opposite diagram.

The standard underlines the fact that “the design shall also ensure that any separated and retained light liquid is not disturbed”.

That is the reason why only the volume of the separation chamber must be taken into account for the classification of the apparatus, i.e. discharge <100 mg/l or 5 mg/l.

Schematic drawing of an oil separator (with only one separation chamber)

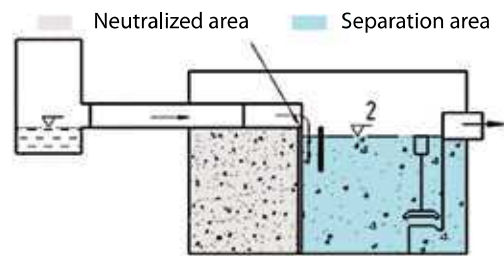

1.3 • The warning device according to the standard

Compulsory in accordance with the NF EN 858-1 6.5.4: “Separator systems shall be provided with automatic warning devices...”

They allow the detection of a certain level of hydrocarbons and/or sludge in the separator. A visual and/or acoustic warning device is activated once the selected level is reached.

2 | Technaeu Recommendations

2.1 • Size of a separator according to the charter

For the equipment with a chamber of separation only, the total useful volume of the apparatus will be at least:

$$\text{Useful volume of a separator} = 90 \text{ sec.} \times \text{NS of the apparatus}$$

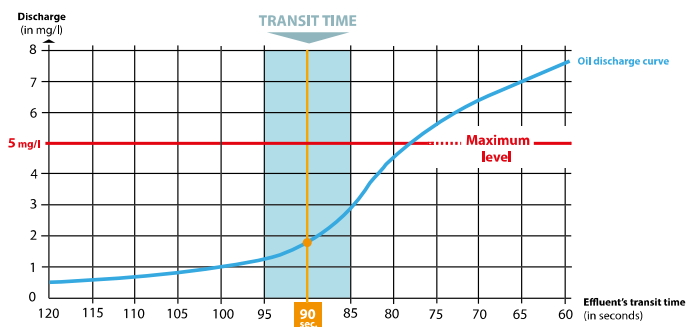

2.2 • Sizing of a separator with both sludge trap and separation chamber according to the charter

For this type of equipment the total useful volume will be at least:

$$\text{Useful volume of a separator with sludge trap} = 190 \text{ sec.} \times \text{NS of the apparatus}$$

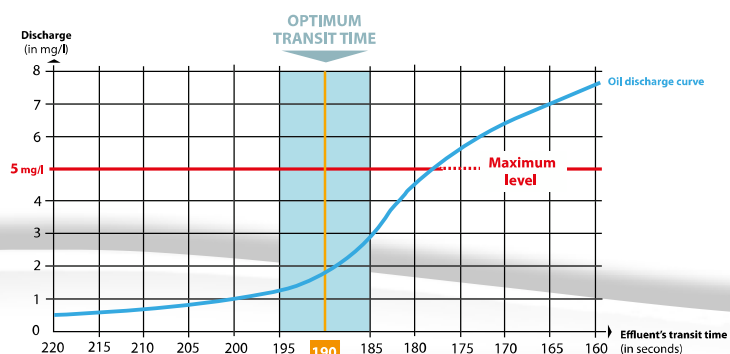



Oil separator

Standards | Quality charter | D.O.P | Operation

2 | Technaueu Recommendations (continued)

Technaueu recommends “a minimum required useful volume” for an optimum treatment and storage of hydrocarbon, e.g. for a nominal size of 100 l/sec., the minimum total useful volume must be equal to:

$$100 \text{ l/s} \times 190 \text{ s} = 19\,000 \text{ litres for a separator with sludge trap.}$$

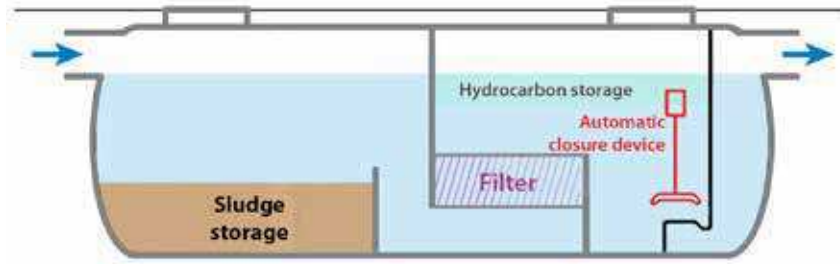

Below this value, the separator’s effectiveness itself is in question as **risks of later release are very high.**



3 | Declaration of Performance (D.O.P)

The manufacturer must be able to provide on simple request “the quality control documents...from the arrival of raw materials through to the final product leaving the factory”.

On the basis of a **quality system in place**, the manufacturer can issue certificates of conformity authorising the affixing of CE marking.

This level 4 certification is based on the manufacturer’s declaration only and does not depend on an external body.

The application of the CE marking is compulsory since the 1st of September 2006. It is regulated by the annex ZA of the NF EN 858-1/A1 February 2005. The certificate of conformity D.O.P is compulsory since the 1st of July 2013. Every product has to be with its D.O.P. which includes CE marking too. The certificate of conformity must include the following elements:

<i>Product: Installation of light liquids separation (for example hydrocarbons) treated in the application area of the norm. Predicted use: Light liquids separation for residual waters to protect waste water systems and surface waters.</i>			
Main parameters	Requirements from the actual norm	Levels or classes	Results
Fire reaction	6.2.8	A.1 to F	-
Liquids reaction	6.3.2	None	Yes / No
Efficiency	4, 6.3.1, 6.3.3 to 6.3.8, 6.5	Class I or II	Yes / No
Load capacity	6.4	1a to 1d	Yes / No
Durability	6.2	None	Yes / No



Oil separator

Standards | Quality charter | D.O.P | Operation

4 | Operation principles

4.1 - Hydraulic flow

Block diagrams of a water treatment apparatus type:

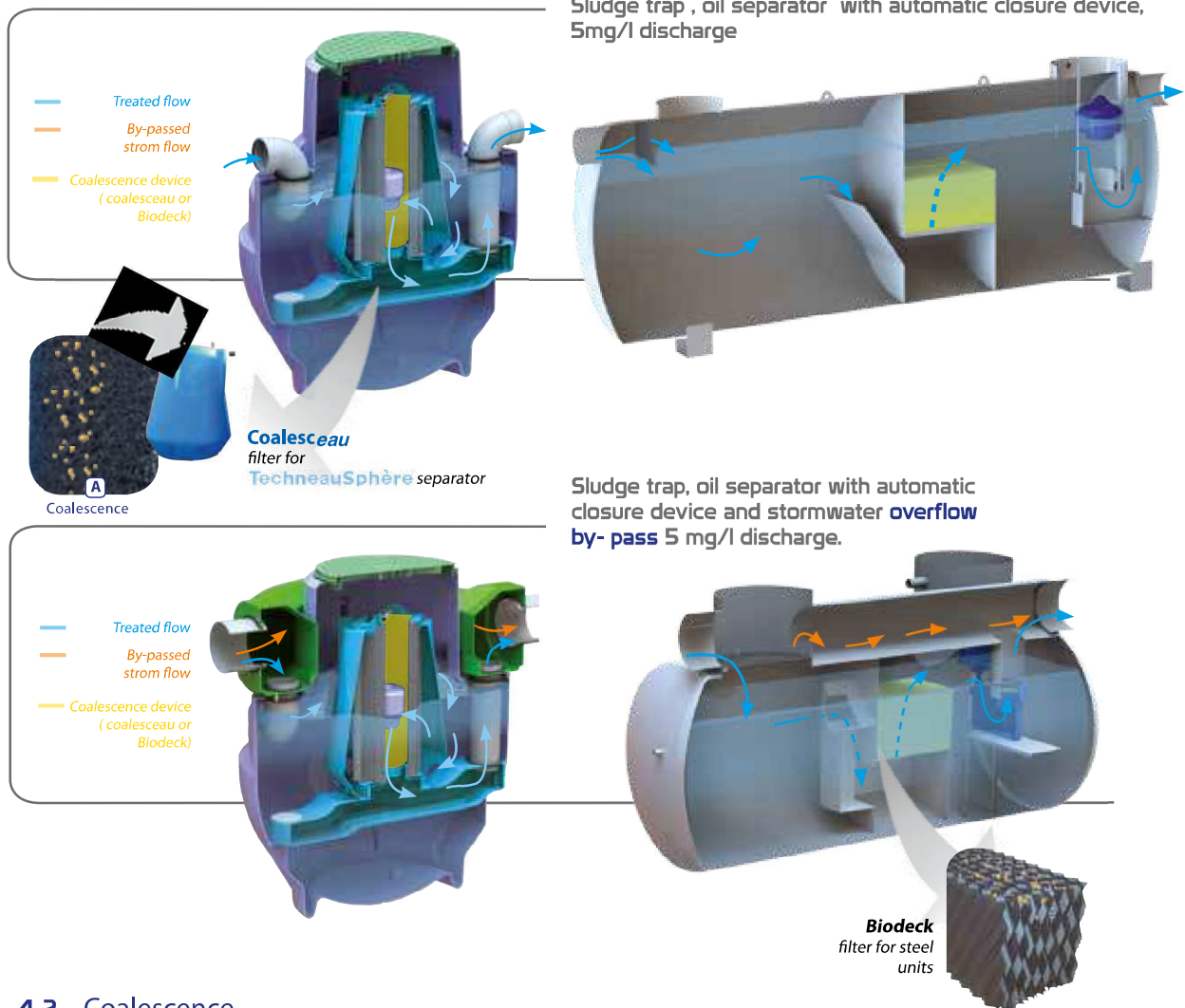

4.2 - Coalescence

The turbulent flow allows the light liquid droplets to merge together through the filter. This increases their volume and thus boosts the flotation. (see detail [schema A](#)).

4.3 - Automatic closure device

Positionned downstream the separation chamber of light liquids, it prevents any accidental release of decanted free hydrocarbon into the downstream network. It is equipped with a siphon bend linked to a float calibrated in accordance with the density of the light liquids to be trapped.

Its operation principle is the following: The float sinks in hydrocarbons and floats in water.

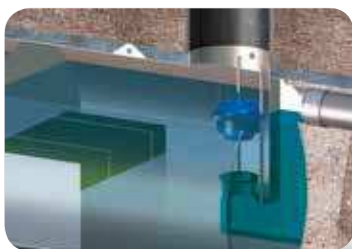

Step 1



Step 2



Step 3



Oil separator

Standards | Quality charter | D.O.P | Operation

5 - Polyethylene TechneauSphère Range: A concentration of innovations

NEW



A new conical automatic closure device

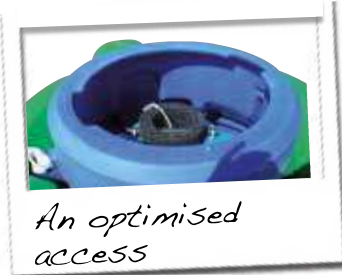

An optimised access



A lockable cover

Model YH0506E

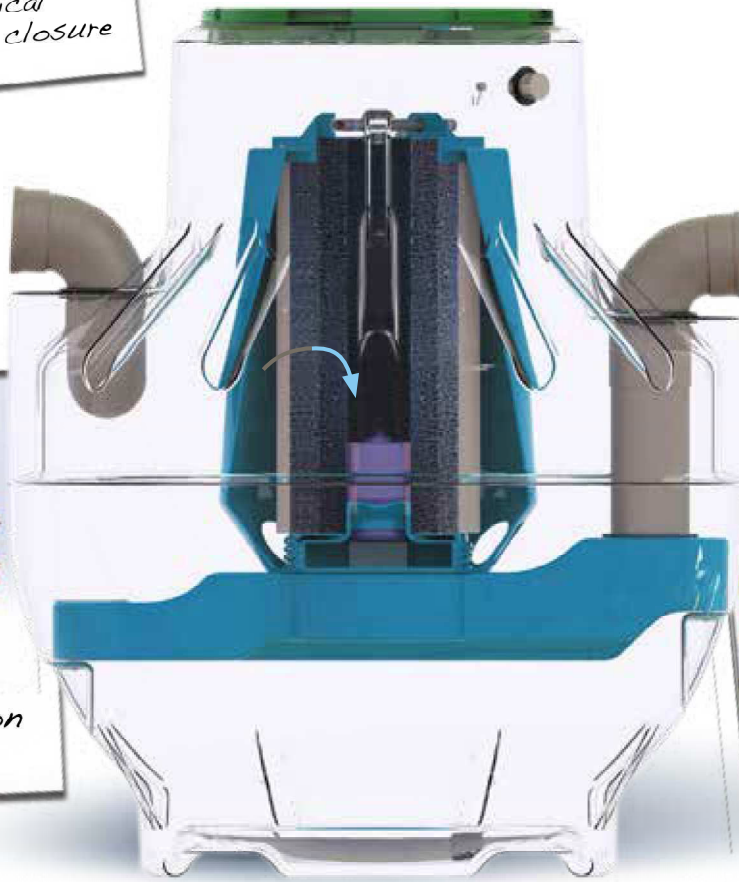

A new conception of the tank

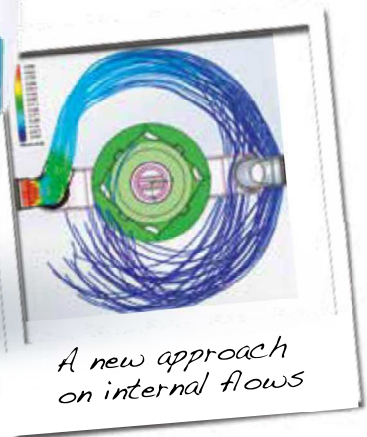

A new approach on internal flows



A new coalescence cell



A central sludge silo





Oil separator

Selection guide / Sites and configurations

1 | The importance of the site in the choice of the separator

1.1 - Selection table

Site		Treatment	Models size 1.5 to 35 l/s				Models size 36 to 500 l/s			
			Polyethylene	Page	Steel	Page	Steel	Page	Polyester	Page
Car park	covered: gravity discharge downstream the separator	100%	YH05/EH05	24	YH05 / ADHF	25	U4	39	U6	38
	underground: pumping downstream the separator	100%	EHR05	32	YHR05 / ADHFR	34	Consult our design office			
Fuel filling and distribution area		100%	YH05 / EH05 / ADHF	24	YH05 / ADHF	25	U4	39	U6	38
Washing area	light-duty vehicles	100%	YH15 / EH15	28	YH15 / ADHFG	29	U4	39	U6	38
	heavy-duty vehicles	100%	YH16 / EH16	28	YH16 / ADHFK	29	U4	39	U6	38
	construction vehicles	100%	YH17- GDHF	28	YH17 / ADHFM	29	U4	39	U6	38
Open area		100%	YH05 / EH05 / ADHF	24	YH05 / ADHF	25	U4	39	U6	38
		20%	YH10 / EH10 / ADHLF	26	YH10 / ADHLF	27	Y1	41	W6	40

1.2 - Various configurations

100% treatment

Direct installation on the network:

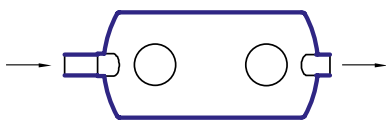

Installation downstream a stormwater tank, with a flow regulator:

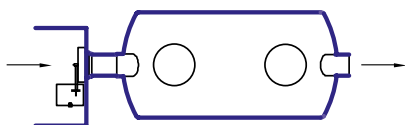

20% treatment

By-pass type installation on the network with regulation storm chamber:

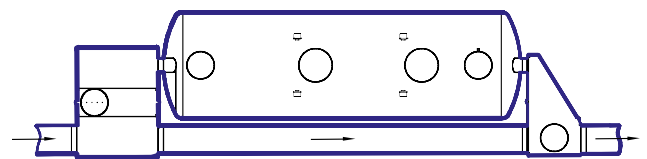

By-pass type installation on the network, with integrated by-pass:

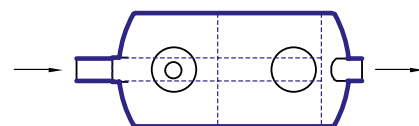



Oil separator

Selection guide / Covered areas and petrol stations



2 | How to choose a separator for covered car parks?

Selection table

Example for an oil separator with sludge trap, 5 mg/l discharge:

Surface in m ²	Number of places	Size in l/s	Covered car park		Underground car park	
			Polyethylene	Steel	Polyethylene	Steel
1 - 500	1 - 15	1,5	YH0501E	YH0501A	EHR0501D	EHR0501A
501 - 1500	16 - 50	3	YH0503E	YH0503A	EHR0503D	EHR0503A
1501 - 3000	51 - 120	6	YH0506E	YH0506A	YH0506A+PU	EHR0506A
3001 - 4000	121 - 160	8	YH0508E	YH0508A	YH0508A+PU	EHR0508A
4001 - 5000	161 - 200	10	YH0510E	YH0510A	YH0510A+PU	EHR0510A
5001 - 8000	201 - 320	15	EH0515D	ADHF115AB	-	ADHFR115AB
8001 - 15000	321 - 600	20	EH0520D	ADHF120AB	-	ADHFR120AB

! *Make sure the total surface includes the external access ramps. Therefore, the size of the separator will be determined on the basis of the most important flow of the two surfaces, to which the fire network flow is added.*

Note that the pumps, the pumping tank will be equipped with, will be determined according to 4 criteria: flow, pumping height, length and diameter of the discharge line (refer to page 33-35).

3 | How to choose a separator for fuel filling and/or fuel distribution areas?

The size of oil separators with sludge traps is defined in France by the decree dated April 15th 2010.

The nominal size of the separator is defined on the basis of a flow rate of 45 l/h/m² for uncovered areas. A factor of 0.5 has to be applied for covered areas (roofed cover).



Selection table

Surface in m ²	Covered surface (roofed cover)			Uncovered surface		
	Size [l/s]	Polyethylene	Steel	Size [l/s]	Polyethylene	Steel
1 - 245	1,5	YH0501E	YH0501A	3	YH0503E	YH0503A
246 - 480	3	YH0503E	YH0503A	6	YH0506E	YH0506A
481 - 640	4	YH0503E	YH0503A	8	YH0508E	YH0508A
641 - 800	5	YH0506E	YH0506A	10	YH0510E	YH0510A
801 - 1000	6	YH0506E	YH0506A	12	EH0515D	ADHF115AB
1001 - 1250	8	YH0508E	YH0508A	15	EH0515D	ADHF115AB
1251 - 1650	10	YH0510E	YH0510A	20	EH0520D	ADHF120AB

! *In the case of a petrol station integrating a car park, it will be necessary to include 2 separators (one with total treatment for the fuel distribution area, the other with partial treatment for the car park).*

Note that for a petrol station partial treatment systems are forbidden.



Oil separator

Selection guide / Washing areas

4 | How to choose a separator for washing areas?

Extract from the EN 858-2 august 2003 Standard:

“The sizing of light liquid separators shall be based on the nature and flow rate of the liquids to be treated”

The following elements need to be taken into account:

- maximum flow of rain water;
- maximum flow rate of waste water (trade effluent);
- density of the light liquid;
- presence of substances that may impede separation (e.g. detergents)

The size of the separator should be calculated from the following formula:

$$NS = (Q_r + (Q_s \times f_x)) \times f_d$$

NS is the nominal size of the separator,

Q_r is the maximum flow rate of rainwater, in l/s,

Q_s is the maximum flow rate of waste water, in l/s,

f_x is the density factor for the relevant light liquid (the factor 1 will be used by default for a density up to 0.85) for higher values consult us,

f_d is the impediment factor depending on the nature of the discharge (the factor 2 will be used in accordance with paragraph 4.1 of the EN 858-2 standard).

The total wastewater inflow is calculated as the sum of contributing flows from the following formula:

$$Q_s = Q_{s1} + Q_{s2} + Q_{s3} + \dots$$

Q_{s1}: flow from draw-off points,

Q_{s2}: flow from automatic car wash,

Q_{s3}: flow from high pressure cleaning units;

...: any other contributing flow.

4.1 - Automatic car washes (roll-over, drive-through)

Wastewater from **low pressure car washes** (with a back pressure up to 20 bar) where only carriage bodies and chassis are cleaned does not usually contain any significant amount of light liquid. Therefore a **flow value (Q_{s2})** of **2 l/s** should be used.

Should there be wastewater from high pressure car washes (with a back pressure higher than 20 bar) and/or any additional washing procedures which will result in wastewater containing light liquids, then for every car wash place or drive through a wastewater value **Q_{s2}** of 2 l/s plus a wastewater value **Q_{s3}** for each **high pressure unit** should be included.

In this configuration, the sludge trap volume must be 5 m³ minimum.





Oil separator

Selection guide / Washing areas

4.2 - High pressure units

Irrespective of the effective use of water from a high pressure unit, a **wastewater value of Q_{s3} of 2 l/s** should be considered. If there is more than one high pressure unit an **additional 1 l/s** shall be included for each unit.

If a **high pressure unit is being used together with an automatic car wash** for this unit a **wastewater value Q_{s3} of 1 l/s** shall be included.



4.2.1 - Selection table

Vehicle type	Polyethylene		Steel	
	Reference	Size (l/s)	Reference	Size (l/s)
Light-duty vehicles	YH1502E	2	YH1502A	3
	YH1506E	6	YH1506A	6
	EH1508D	8	ADHFG210A	10
Heavy-duty vehicles	YH1604E	4	YH1604A	3
	EH1606D	6	ADHFK306A	6
Construction vehicles	YH1703E	3	YH1703A	3
	GDHF510E	10	ADHFM506A	6



Oil separator

Selection guide / Uncovered areas

5 | How to choose a separator for uncovered areas? - total treatment?

The ten-year peak flow depends on the area to be treated and on the local rain zone (e.g. France is divided into 3 rain zones **(ZONE 1, 2 or 3)**).

For areas < 10 000 m², the calculation method, according to NF EN 752-4 standard is as follows:

$$Q_{10} = Q_T = \psi \times I \times A$$

Q₁₀: ten-year peak flow rate (litres/second)

Q_T: treatment flow rate (litres/second)

ψ: run-off coefficient (depends on the zone: 0.9 for concrete or asphalt)

I: rainfall intensity

(litres/second/hectare) depending on geographical areas (in ten-year flow rate).

For instance, in France:

ZONE 1: 300 l/s/ha - **ZONE 2**: 400 l/s/ha - **ZONE 3**: 500 l/s/ha

A: area receiving rainfall (hectares)

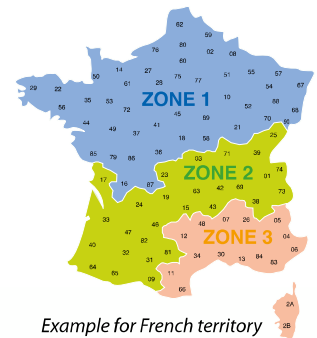

Example for French territory

Selection table for separators **without by-pass**

100% treatment of inflow

ZONE 1 (m ²)	ZONE 2 (m ²)	ZONE 3 (m ²)	Size (l/s)	Polyethylene	Steel	Polyester
1 to 90	1 to 65	1 to 55	1,5	YH0501E	YH0501A	-
91 to 145	66 to 110	56 to 85	3	YH0503E	YH0503A	-
146 to 255	111 to 190	86 to 155	6	YH0506E	YH0506A	-
256 to 330	191 to 250	156 to 200	8	YH0508E	YH0508A	-
331 to 405	251 to 300	201 to 265	10	YH0510E	YH0510A	-
406 to 630	301 to 470	266 to 375	15	EH0515D	ADHF115AB	-
631 to 810	471 to 610	376 to 485	20	EH0520D	ADHF120AB	U6ACA2P
811 to 1000	611 to 750	486 to 610	25	ADHF125E	ADHF125AB	U6ACF2P
1001 to 1200	751 to 900	611 to 720	30	ADHF130E	ADHF130AB	U6ADA2P
1201 to 1380	901 to 1020	721 to 830	35	-	ADHF135AB	U6ADF3P
1381 to 1570	1021 to 1160	831 to 940	40	-	U4AEA3A	U6AEA3P
1571 to 1700	1161 to 1270	941 to 1030	45	-	U4AEF3A	U6AEF3P
1701 to 1900	1271 to 1450	1031 to 1150	50	-	U4AFA5A	U6AFA3P



Oil separator

Selection guide / Covered areas

6 | How to choose a separator for uncovered areas? - partial treatment?

The ten-year peak flow depends on the area to be treated and on the local rain zone (e.g. France is divided into 3 rain zones **(ZONE 1, 2 or 3)**).

For areas < 10 000 m², the calculation method, according to NF EN 752-4 standard is as follows:

$$Q_{10} = \psi \times I \times A$$

$$Q_T = 20\% Q_{10}$$

Q₁₀: ten-year peak flow rate (litres/second)

Q_T: treatment flow rate (litres/second)

ψ: run-off coefficient (depends on the zone: 0.9 for concrete or asphalt)

I: rainfall intensity

(litres/second/hectare) depending on geographical areas (in ten-year flow rate).

For instance, in France:

ZONE 1: 300 l/s/ha - **ZONE 2**: 400 l/s/ha - **ZONE 3**: 500 l/s/ha

A: area receiving rainfall (hectares)

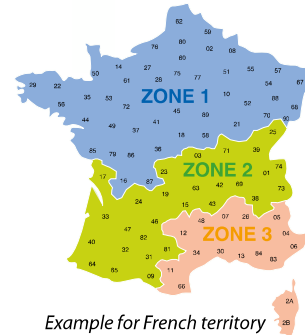

Example for French territory

Selection table for separators with by-pass

20% treatment of inflow

ZONE 1 (m ²)	ZONE 2 (m ²)	ZONE 3 (m ²)	Size (l/s)	Polyethylene	Steel	Polyester
1 to 280	1 to 220	1 to 170	1,5	YH1001E	YH1001A	-
281 to 830	221 to 620	171 to 500	3	YH1003E	YH1003A	-
831 to 1185	621 to 888	501 to 711	6	YH1006E	YH1006A	-
1186 to 1555	889 to 1166	712 to 933	8	YH1008E	YH1008A	-
1156 to 2310	1167 to 1730	934 to 1385	10	YH1010E	YH1010A	-
2311 to 3230	1731 to 2430	1386 to 1940	15	EH1015D	ADHFL115AB	-
3231 to 4160	2431 to 3120	1941 to 2500	20	EH1020D	ADHFL120AB	W6ACA3P
4161 to 5080	3121 to 3820	2501 to 3050	25	ADHFL125E	ADHFL125AB	W6ACF4P
5081 to 6000	3821 to 4500	3051 to 3600	30	ADHFL130E	ADHFL130AB	W6ADA4P
6001 to 6900	4501 to 5200	3601 to 4150	35	-	ADHFL135AB	W6ADF4P
6901 to 7870	5201 to 5900	4151 to 4700	40	-	Y1AEA4A	W6AEA4P
7871 to 8795	5901 to 6590	4701 to 5250	45	-	Y1AEF4A	W6AEF4P
8796 to 9720	6591 to 7290	5251 to 5830	50	-	Y1AFA5A	W6AFA5P



Oil separator with sludge trap & coalescing filter



Class I
Discharge < 5 mg/l
Size 1,5 to 30 l/s

Recyclable polyethylene tanks produced by rotomoulding. Vertical automatic closure device, calibrated at 0.85.

• TechneauSphère range:

PVC inlet and outlet,
Polyethylene cover,
Removable coalescing filter protected

from the sludge by an inner wall.

• Ellipse range:

Inlet and outlet with nitrile seals,
Polyethylene manholes,
Polyethylene inner wall with filter holder and coalescing filter.

• Aronde range:

PVC inlet and outlet,
Polyethylene manholes,
Polyethylene inner wall with filter holder and coalescing filter.

OPTION

• Visual and audible alarm see p. 83

TechneauSphère

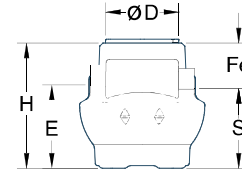
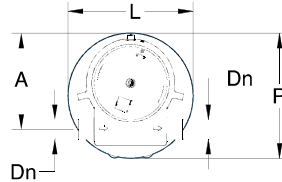

YH0501E	Size l/s	P	L	H	E	S	Fe	Dn	A	Weight	Useful volume		ø D
											Sludge trap	Separator	
YH0501E	1,5	1000	1000	1000	669	639	361	110	770	37	150	190	585

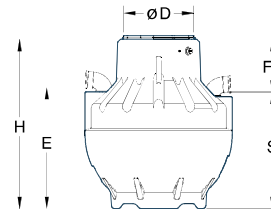
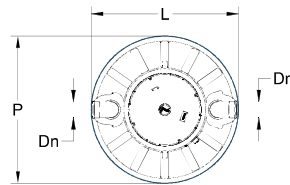

YH0503E	Size l/s	P	L	H	E	S	Fe	Dn	Weight	Useful volume		ø D
										Sludge trap	Separator	
YH0503E	3	1200	1200	1230	840	800	430	110	40	300	359	585
YH0506E	6	1500	1500	1700	1200	1150	550	160	88	600	900	745
YH0508E	8	1500	1500	1700	1200	1150	550	160	88	800	720	745
YH0510E	10	1500	1500	1965	1450	1400	565	160	114	1000	940	745

Ellipse

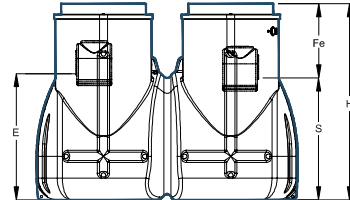
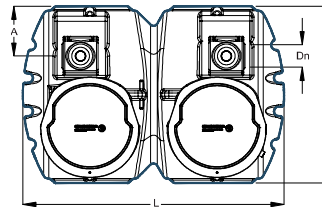

Ref. range EH05	Size l/s	L	P	H	E	S	Fe	Dn	A	Useful volume		Weight	Manhole type
										Sludge trap	Separator		
EH0515D	15	2400	1624	1803	1160	1120	683	200	457	1500	1730	229	BCE10
EH0520D	20	2400	1624	2175	1532	1492	683	200	457	2000	2060	257	

Aronde

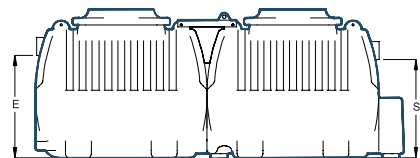
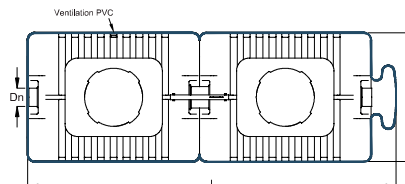

Ref. range ADHFE	Size l/s	L	P	H	E	S	Fe	Dn	Volume		Weight
									Sludge trap	Separator	
ADHF125E	25	4292	1500	1730	1200	1150	580	200	2500	3700	312
ADHF130E	30	4300	1555	1730	1200	1150	580	200	3000	3200	317

Dimensions are given in mm, weights in kg, volumes in litres.



Oil separator with sludge trap and coalescing filter



Class I
Discharge < 5 mg/l
Size 1,5 - 35 l/s

Steel tank with hoisting rings.
Bi-component coating based on poly-
amid adduct/epoxy resins.
Inlet and outlet in PVC
Vertical polyethylene **automatic clo-
sure device** calibrated at 0.85 (other
calibrations on request).

• **Hydrocube Range:**
Polyethylene cover.
Conical partition module- coalescing
filter (CCF) completely removable.

• **Hydrobac Range:**
Cylindrical manhole(s) without cover,
Coalescing filter removable.

OPTIONS

- Polyethylene extension type E see p. 82
- Visual and audible alarm see p. 83



Inside Separator detail

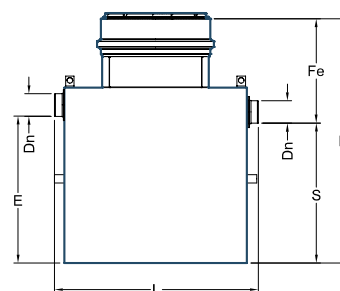
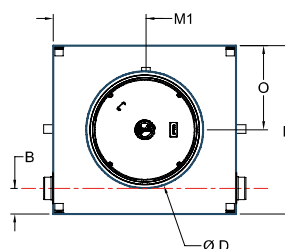

Ref. range YH05A	Size l/s	L	P	H	E	S	M1	O	B	Fe	Dn	Ø D	Volume		Weight
													Sludge trap	Separator	
YH0501A	1,5	885	745	1200	660	630	372	302	117	570	110	585	150	200	110
YH0503A	3	1122	995	1200	790	750	497	497	200	449	110	585	300	442	151
YH0506A	6	1466	1200	1739	1050	1000	650	600	190	740	160	745	600	960	247
YH0508A	8	1500	1200	1989	1270	1219	650	600	190	770	160	745	800	970	353
YH0510A	10	1550	1200	1989	1270	1219	650	600	190	770	160	745	1000	1000	360

HydroCube

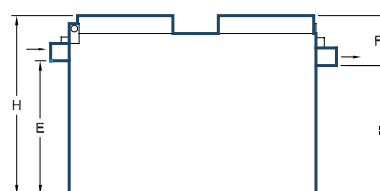
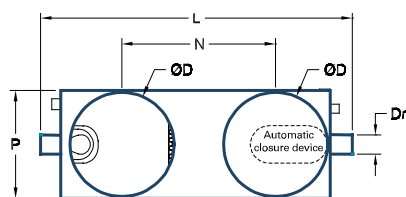

OPTION
Visual and audible alarm see p. 83

Ref. range ADHLFAB	Size l/s	L	P	H	E	S	Fe	Dn	Volume		Weight	Manhole(s)		
									Sludge trap	Separator		Nb	D	N
ADHF115AB	15	2170	830	2110	1660	1610	500	200	1500	1350	561	2	750	1120
ADHF120AB	20	3100	830	2000	1550	1500	500	200	2000	1800	664	2	750	1350
ADHF125AB	25	3030	1200	1920	1470	1420	500	200	2500	2270	805	2	750	1771
ADHF130AB	30	3630	1200	1920	1470	1420	500	200	3000	2794	938	2	750	2221
ADHF135AB	35	4350	1200	2110	1470	1420	690	315	3500	3316	1180	2	750/950	2671

Dimensions are given in mm, weights in kg, volumes in litres.



Oil separator with sludge trap, coalescing filter & by-pass



Class I
Discharge < 5 mg/l
Size 1,5 to 30 l/s

Recyclable polyethylene tanks produced by rotomoulding.

Vertical automatic closure device, calibrated at 0.85.

Inlet and outlet with nitrile seals (except YH1001E: inlet and outlet in PVC).

Inlet device with overflow blade and siphon partition to feed the by-pass.

- **TechneauSphère range:**
Polyethylene cover,
Removable coalescing filter protected from the sludge by an inner wall.

- **Ellipse and Aronde ranges:**
Polyethylene manholes,
Polyethylene inner wall with filter holder and coalescing filter.

OPTION

- **Visual and audible alarm** see p. 83

TechneauSphère

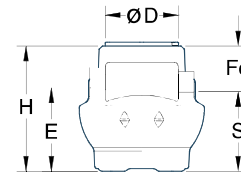
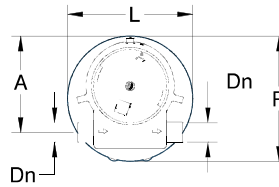

YH1001E	Size l/s	P	L	H	E	S	Fe	Dn	A	Weight	Useful volume		ø D
											Sludge trap	Separator	
	1,5	1000	1000	1000	665	635	365	160	770	38	150	190	585

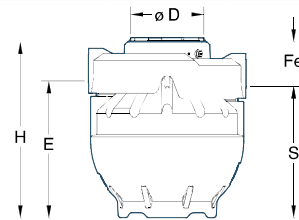
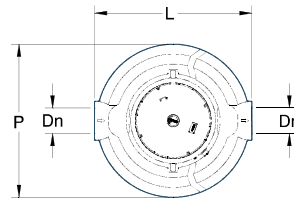

YH1003E	Size l/s	P	L	H	E	S	Fe	Dn	Weight	Useful volume		ø D
										Sludge trap	Separator	
	3	1200	1200	1230	880	840	390	200	54	300	359	585
	6	1500	1500	1700	1330	1280	420	250	117	600	900	745
	8	1500	1500	1700	1260	1210	490	315	117	800	720	745
	10	1500	1500	1965	1500	1450	515	315	145	1000	940	745

Ellipse

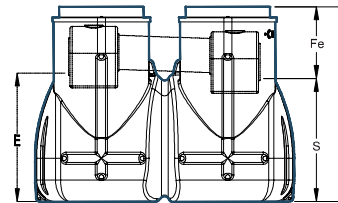
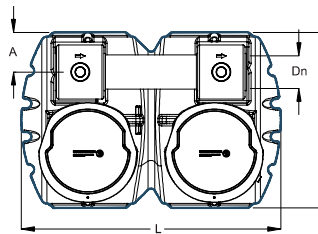

Ref. range EHID	Size l/s	L	P	H	E	S	Fe	Dn	A	Useful volume		Weight	Manhole type
										Sludge trap	Separator		
EH1015D	15	2400	1624	1803	1189	1139	664	315	457	1500	1680	241	BCE10
EH1020D	20			2175	1513	1513	713	400		2000	2040		

Aronde

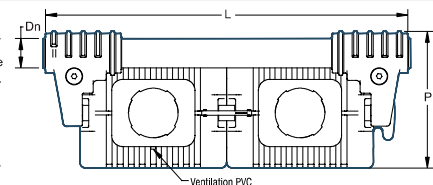
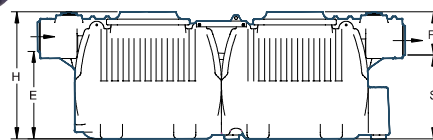

Ref. range ADHLFE	Size l/s	L	P	H	E	S	Fe	Dn	Volume		Weight
									Sludge trap	Separator	
ADHLF125E	25	4300	1555	1730	1080	980	750	400	2500	2700	336
ADHLF130E	30	4960	1880		1200	1150	580		3000	3200	356

Dimensions are given in mm, weights in kg, volumes in litres.



Oil separator with sludge trap, coalescing filter & by-pass



Class I
Discharge < 5 mg/l
Size 1.5 - 35 l/s

Steel tank with hoisting rings.

Bi-component coating based on polyamid adduct/epoxy resins.

Inlet and outlet in steel.

Vertical polyethylene **automatic closure device** calibrated at 0.85 (other calibrations on request).

Inlet with **overflow blade and siphon partition** to feed the by-pass.

• **Hydrocube Range:**
Polyethylene cover.
Conical partition module- coalescing filter (CCF) completely removable.

• **Hydrobac Range:**
Cylindrical manhole(s) without cover,
Coalescing filter removable.

OPTIONS

- **Polyethylene extension E type** see p. 82
- **Visual and audible alarm** see p. 83



Ref. YH0501A

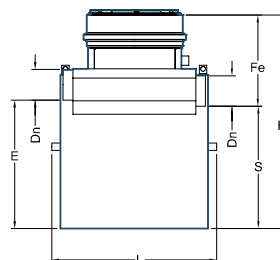
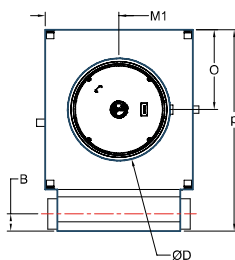

Ref. range ADHFA	Size l/s	L	P	H	E	S	M1	O	B	Fe	Dn	Ø D	Volume		Weight
													Sludge trap	Separator	
YH1001A	1,5	923	745	1200	660	632	372	302	128	568	160	585	150	200	112
YH1003A	3	1155	995	1484	780	740	437	382	150	745	200	745	300	432	165

HydroCube



Ref. YH0506A

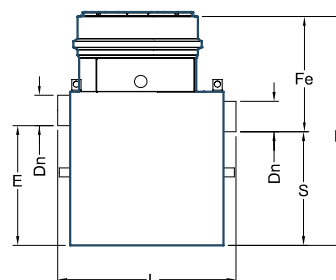
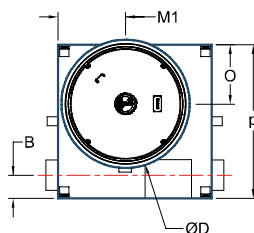

Ref. range YH10A	Size l/s	L	P	H	E	S	M1	O	B	Fe	Dn	Ø D	Volume		Weight
													Sludge trap	Separator	
YH1006A	6	1340	1640	1739	1050	1000	600	650	140	739	250	745	600	960	274
YH1008A	8	1340	1660	1989	1170	1120	600	650	160	870	315	745	800	880	389
YH1010A	10	1350	1660	1989	1170	1120	600	650	160	870	315	745	1000	900	394

OPTION

Visual and audible alarm see p. 83

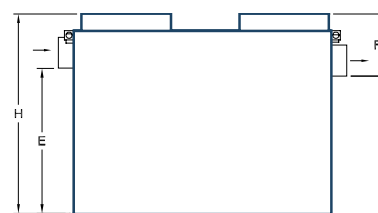
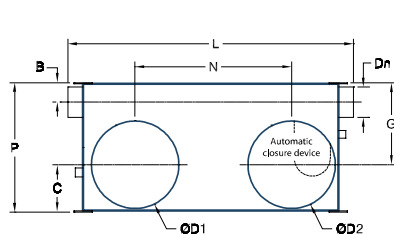

Ref. range ADH112AB	Size l/s	L	P	H	E	S	Fe	Dn	B	Volume		Weight	Manhole(s)					
										Sludge trap	Separator		Nb	Ø D1	Ø D2	N	C	G
ADH112AB	12	1950	1300	1650	1146	1046	604	315	169	1200	1120	580	2	750	750	930	550	915
ADH115AB	15	2250	1200	1760	1320	1220	540	315	230	1500	1430	665	2	750	750	1170	425	775
ADH120AB	20	2750	1250	1910	1320	1220	690	400	230	2000	1965	787	2	750	750	1670	425	825
ADH125AB	25	3050	1200	2110	1520	1420	690	400	215	2500	2270	880	2	750	750	2010	395	805
ADH130AB	30	3650	1200	2110	1520	1420	690	400	215	3000	2790	1030	2	750	750	2610	395	805
ADH135AB	35	4250	1200	2110	1520	1420	690	400	215	3500	3310	1217	2	750	950	3110	395	705

HydroBac

Dimensions are given in mm, weights in kg, volumes in litres.



Oil separator with big sludge trap & coalescing filter



Class I
Discharge < 5 mg/l
Size 2 to 10 l/s

Recyclable polyethylene tanks produced by rotomoulding. Vertical automatic closure device, calibrated at 0.85.

• **TechneauSphère range:**
PVC inlet and outlet,
Polyethylene cover,

Removable coalescing filter protected from the sludge by an inner wall.

• **Ellipse range:**
Inlet and outlet with nitrile seals,
Polyethylene manholes,
Polyethylene inner wall with filter holder and coalescing filter.

• **Aronde range:**
PVC inlet and outlet,
Polyethylene manholes,
Polyethylene inner wall with filter holder and coalescing filter.

OPTION

• **Visual and audible alarm** see p. 83

Especially for washing area

* For models with size ≥ 4 l/s

TechneauSphère

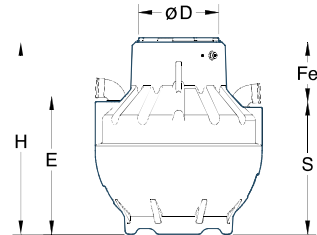
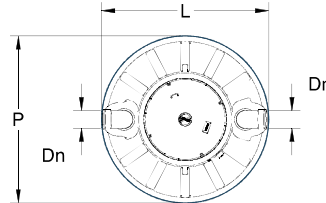

Ref. range YH15-YH16-YH17	Size l/s	P	L	H	E	S	Fe	Dn	Weight	Useful volume		ø D
										Sludge trap	Separator	
YH1502E	2	1200	1200	1230	840	800	430	110	40	400	259	585
YH1703E	3	1500	1500	1700	1200	1150	550	110	86	1200	300	745
YH1604E	4	1500	1500	1700	1200	1150	550	110	86	1200	320	745
YH1506E	6	1500	1500	1965	1450	1400	565	160	114	1200	740	745

Ellipse

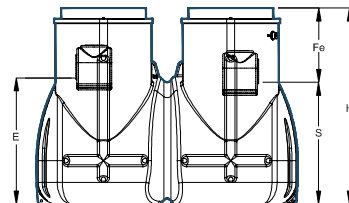
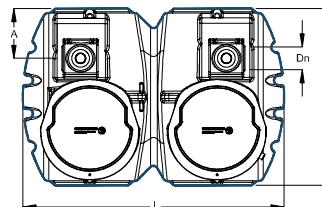

Ref. range EH15-EH16	Size l/s	L	P	H	E	S	Fe	Dn	A	Useful volume		Weight	Manhole type
										Sludge trap	Separator		
EH1606D	6	2400	1624	1803	1180	1140	663	160	457	1520	1740	229	BCE10
EH1508D	8	2400	1624	2175	1552	1512				1900	2190	258	

Aronde

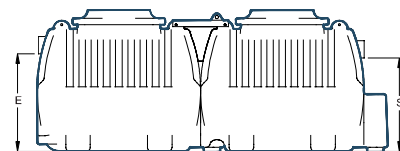
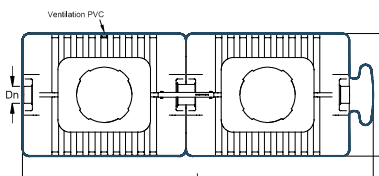

Ref. range AGDHFE	Size l/s	L	P	H	E	S	Fe	Dn	Volume		Weight
									Sludge trap	Separator	
AGDHF510E	10	4292	1500	1730	1200	1150	580	160	5000	1200	296

Dimensions are given in mm, weights in kg, volumes in litres.



Oil separator with big sludge trap and coalescing filter



Class I
Discharge < 5 mg/l
Size 2 - 10 l/s

Steel **tank** with hoisting rings.

Bi-component coating based on polyamid adduct/epoxy resins.

Inlet and outlet in PVC

Vertical polyethylene **automatic closure device** calibrated at 0.85

(other calibrations on request).

• **Hydrocube Range:**

Polyethylene cover.

Conical partition module- coalescing filter (CCF) completely removable.

• **Hydrobac Range:**

Cylindrical manhole(s) without cover,

Coalescing filter removable.

OPTIONS

- **Polyethylene extension E type** see p. 82
- **Visual and audible alarm** see p. 83

HydroCube



Inside Separator detail

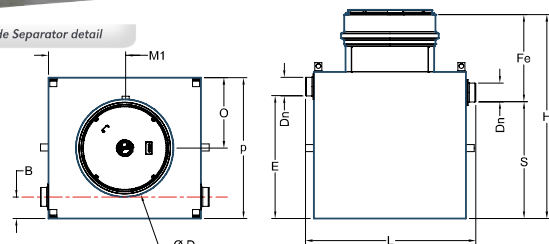

Ref. range YH15A/16A/17A	Size l/s	L	P	H	E	S	M1	O	B	Fe	Dn	ø D	Volume		Weight
													Sludge trap	Separator	
YH1502A	2	1122	995	1200	790	750	497	497	200	449	110	585	400	442	151
YH1703A	3	1466	1200	1739	1050	1000	650	600	190	740	110	745	1200	270	247
YH1604A	4	1466	1200	1739	1050	1000	650	600	190	740	110	745	1200	360	247
YH1506A	6	1500	1200	1989	1270	1219	650	600	190	770	160	745	1200	800	353

HydroBac

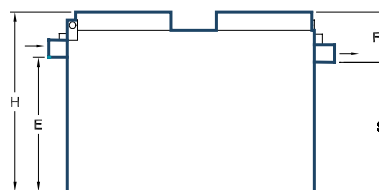

OPTION
Visual and audible alarm see p. 83

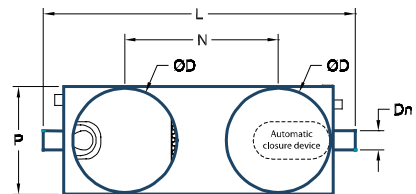

Ref. range ADHFK/ADHFM/ ADHFG	Size l/s	L	P	H	E	S	Fe	Dn	Volume		Weight	Manhole(s)		
									Sludge trap	Separator		Nb	D	N
ADHFK306A	6	2200	830	1900	1550	1500	400	160	1800	690	496	2	580	1070
ADHFM506A	6	2500	830	2200	1850	1800	400	160	3000	480	612	2	580	1370
ADHFG210A	10	2500	1040	1900	1550	1500	400	160	2000	800	454	2	780	1200

Dimensions are given in mm, weights in kg, volumes in litres.



Oil separator with coalescing filter



Class I
Discharge < 5 mg/l
Size 3 to 50 l/s

Recyclable polyethylene tanks produced by rotomoulding. Vertical automatic closure device, calibrated at 0.85.

• TechneauSphère range:

PVC inlet and outlet, Polyethylene cover,

Removable coalescing filter protected from the sludge by an inner wall.

• Ellipse range:

Inlet and outlet with nitrile seals, Polyethylene manholes, Polyethylene inner wall with filter holder and coalescing filter.

• Aronde range:

PVC inlet and outlet, Polyethylene manholes, Polyethylene inner wall with filter holder and coalescing filter.

OPTION

• **Visual and audible alarm** see p. 83

TechneauSphère

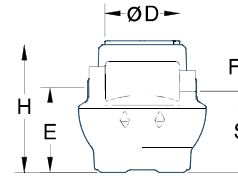
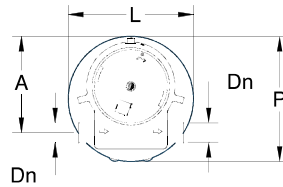

YH2003E	Size l/s	P	L	H	E	S	Fe	Dn	A	Weight	Useful volume	
											Separator	ø D
	3	1000	1000	1000	669	639	361	110	770	37	340	585

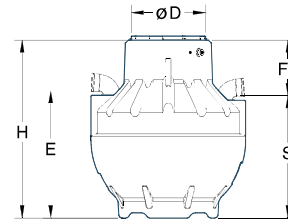
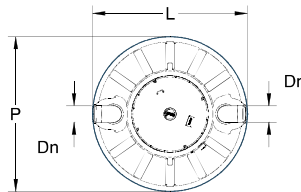

YH2010E	Size l/s	P	L	H	E	S	Fe	Dn	Weight	Useful volume	
										Separator	ø D
	10	1500	1500	1700	1200	1150	550	160	88	1520	745

Ellipse

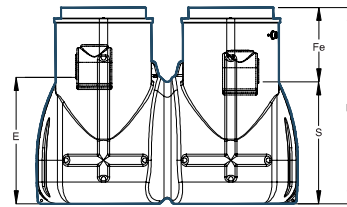
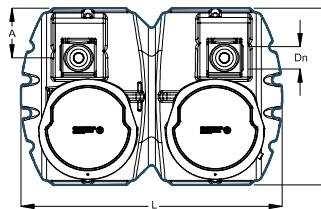

Ref. range EH20	Size l/s	L	P	H	E	S	Fe	Dn	A	Volume Separator	Weight	Manhole type
EH2020D	20	2400	1624	1803	1160	1120	683	200	457	2900	229	BCE10

Aronde

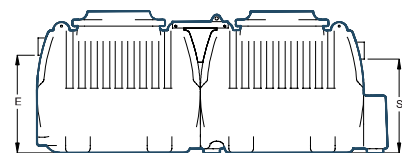
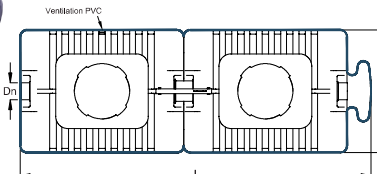

Ref. range AHFE	Size l/s	L	P	H	E	S	Fe	Dn	Volume Separator	Weight
AHF130E	30	2292	1500	1730	1085	1065	665	200	3100	187
AHF150E	50	4300		1055	1035	695	300	5700	317	

Dimensions are given in mm, weights in kg, volumes in litres.



Oil separator with coalescing filter



Class I
Discharge < 5 mg/l
Size 3 - 10 l/s

Steel **tank** with hoisting rings.

Bi-component coating based on polyamid adduct/epoxy resins.

Inlet and outlet in PVC

Vertical polyethylene **automatic closure device** calibrated at 0.85 (other calibrations on request).

• **Hydrocube Range:**

Polyethylene cover.
Conical partition module- coalescing filter (CCF) completely removable.

• **Hydrobac Range:**

Cylindrical manhole(s) without cover,
Coalescing filter removable.

OPTIONS

- Polyethylene extension
E type see p. 82
- Visual and audible alarm
see p. 83

HydroCube

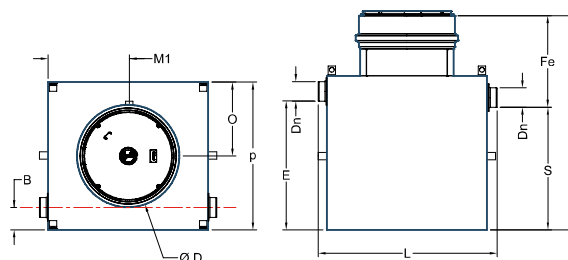

Ref. range YH20A	Size l/s	L	P	H	E	S	M1	O	B	Fe	Dn	ø D	Volume Separator	Weight
YH2003A	3	885	745	1200	660	630	372	302	117	570	110	585	350	110
YH2010A	10	1466	1200	1739	1050	1000	650	600	190	740	160	745	1560	247



Oil separator with coalescing filter and lift tank



Class I
 Discharge < 5 mg/l
 Size 1,5 - 3l/s

Use

- Ideal for runoff water requiring downstream pumping,
- Underground installation inside or outside the building

Design

- Recyclable polyethylene rotomoulded tank insensitive to corrosion
- Integrated reinforcements for a better mechanical resistance
- Inlet device DN 110 with nitrile seal
- Polyethylene inner wall with filter holder and coalescing filter
- Polyethylene automatic closure device calibrated at 0,85

- 1 polyethylene anti-slip cover with stainless screws for a secure pedestrian traffic
- 1 polyethylene manhole (can be shortened/adjustable)
- PVC female DN 50 ventilation bonding sleeve
- PVC outlet sleeve/hose DN 63
- Lifting straps for easy handling
- DN 50 bonding cable gland sleeve

Internal Equipment

- 1 integrated pumping station
- 1 single-phase submersible 230V pump, type Wilo SBS 2/204 assembled with union fitting for quick removal
- 1 PVC ball check valve DN 40

Especially for underground car park

The product's advantage:

compact single-package unit combining water treatment and pumping.

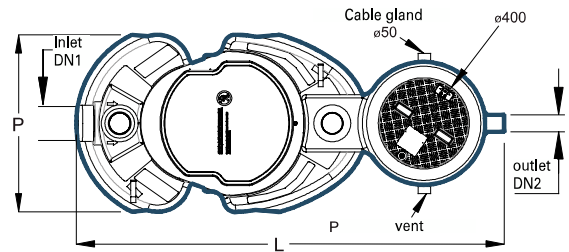

EHR

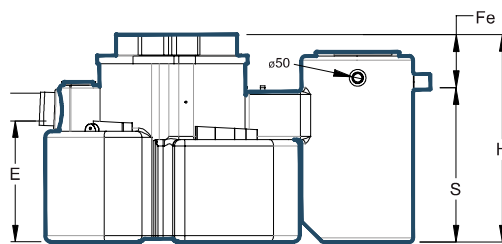

Model EHR 0501C

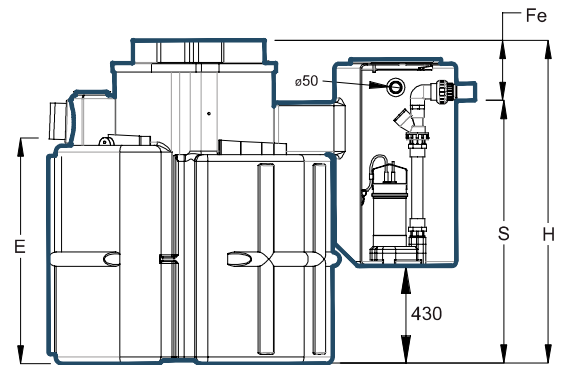

Model EHR 0503C

Ref Range EHR	Pump Type	Size l/s	L	P	H	E	S	Fe	Dn1 inlet	Dn2 outlet	Volume			Weight	Manhole Type
											Sludge trap	Separator	Pumping		
EHR0501D	WILO	1,5	1876		994	575	740				150	190		68	BCE05
EHR0503D	SBS 2 204	3	1888	778	1424	1005	1170	254	110	63	300	350	90	85	

Dimensions are given in mm, weight in kg, volume in litres



Oil separator with sludge trap, coalescing filter and lift tank



Class I
Discharge < 5 mg/l
Size 1,5 - 10 l/s

- Steel tank with hoisting rings.
- Bi-component coating based on polyamid adduct/epoxy resins.
- Inlet and outlet in PVC.
- Vertical polyethylene automatic closure device calibrated at 0.85 (other calibrations on request).
- Conical partition module- coalescing filter (CCF) completely removable.
- Cable and ventilation Stitching Dn50.
- Incorporated lift tank (Optional pumps kit).
- Tank discharge outlet in threaded steel coil 2" 1/2.
- 3 pieces union connection tapped/ female to glue D75 supplied with tank.

OPTIONS

- Polyethylene extensions E type see p. 82
- Visual and audible alarm see p. 83
- 1 or 2 pumps kit (with control panel) see opposite reference

HydroBac with Pumping chamber



The different chambers:

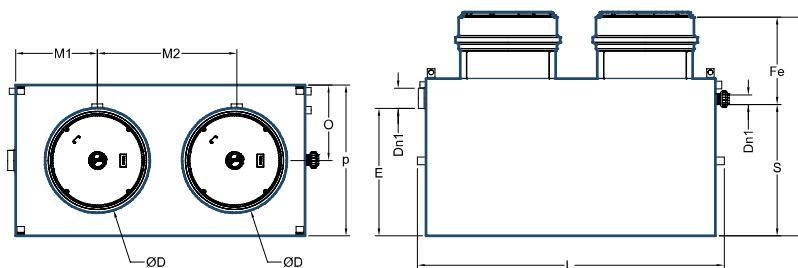

References	Size l/s	L	P	H	E	S	M1	M2	O	Fe	Dn1	øD	Volume			Weight
													Sludge trap	Separator	Pumping	
YHR0501A	1,5	2123	900	1489	657	800	372	1101	385	689	110	745	150	200	622	275
YHR0503A	3	2130	995	1489	790	800	500	980	497	689	110	745	300	442	700	296
YHR0506A	6	2440	1200	1739	1020	1050	650	1090	600	689	160	745	600	960	1080	462
YHR0508A	8	2440	1200	1989	1270	1300	650	1090	600	689	160	745	800	970	1250	628
YHR0510A	10	2440	1200	1989	1270	1300	650	1090	600	689	160	745	1000	1000	1250	628

Dimensions are given in mm, weights in kg, volumes in litres.



Oil separator

Pump kits for the lift tank

Class I
Discharge < 5 mg/l
Size 1,5 - 10 l/s

1 or 2 pumps, choose your "pumping kit" according to the:

a static head (Hg)

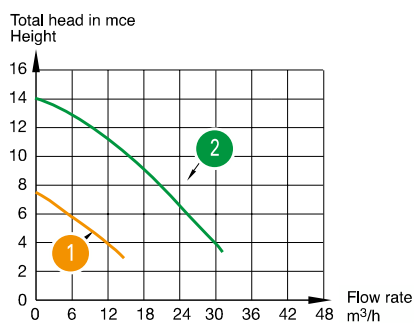
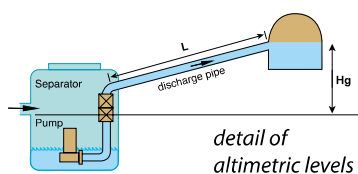

b nominal size of the separator

Kit description:

Especially suited to equip separators ref YHRA
Kit selection depends on flow rate and total head
(= static head + pressure loss).

Component kit:

- 1 or 2 submersible pump(s) with or without discharge pipe connector
- PVC pressure pipes with connections
- 1 or 2 non-return valve
- 1 or 3 level floats with counterbalanced chains
- 1 control panel for the 2 pumps kit



Lift kit
1 or 2 pumps - Separator ADHFRA

a Choice according to static head (Hg)

Ref.	Pump type	Plastic foot brackets	Number of pumps	Regulation	Dn2 Discharge	Power Kw	Voltage V	Current A	Discharge Internal Pipes	Curve's number
KP11P	Feka 600	yes	1		2"1/2	0,55	230	4,3	40	1
KP21P		yes	2	 (with control box and 1 alarm float)	2"1/2	0,55	230	4,3	40	
KP16P	Feka 1200 automatic	yes	1		2"1/2	1,2	230	8,6	50	2
KP26P	Feka 1200	yes	2	 (with control box and 1 alarm float)	2"1/2	1,2	230	8,6	50	

b Choice according to nominal size of the separator

Ref. range YHRA	Pump Kit KP11P	Pump Kit KP21P	Pump Kit KP16P	Pump Kit KP26P
YHR0501A	•	•		
YHR0503A	•	•		
YHR0506A		•	•	
YHR0508A			•	•
YHR0510A				•



Control and protection panel CSDRCP for 2 pumps kit.

Ensure the complete control and protection of the lift tank using regulation with aero system linked to an immersed tube in the tank. A constant air induction in the tube prevents from clogging.

Finally, the control panel ensure a complete protection of pumps from over-intensity, under-intensity and lack of phase.

Main functions:

- Visual and audible alarm on alarm float.
- Lockable breaker.
- Forced operation of the pumps with pushbutton.



Battery-acid neutralization tank

- Polyethylene **tank** produced by rotomoulding.
- Polyethylene **inlet/outlet** device,
- Polyethylene **cover**,
- **1 neutralization column** with removable basket(s)

• **Operation:** this equipment is intended to neutralize battery acids before a discharge into the network.
It is specially adapted to treat waste water from battery storage or maintenance shops or chemistry room.

It is composed of a polyethylene tank with from 1 to 3 marble filter baskets (following references) in contact with which the acid is neutralized.

OPTION



Fixed extension (no telescopic), 2 available heights:

- 200 mm, 6 kgs **PLA13555G**
- 400 mm, 8 kgs **PLA13556G**

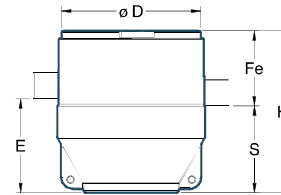
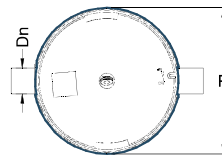

Reference	Useful Volume	P	H	E	S	Fe	Dn	Weight	ø D
YN00E	110	622	680	400	370	3100	110	16	585

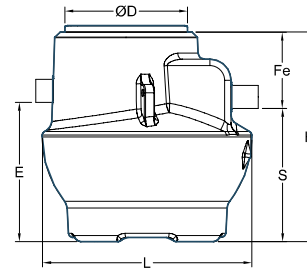
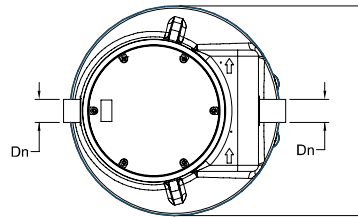

Reference	Useful Volume	P	L	H	E	S	Fe	Dn	Weight	ø D
YN01E	340	1000	1000	1000	670	640	360	110	31	585

Sphère

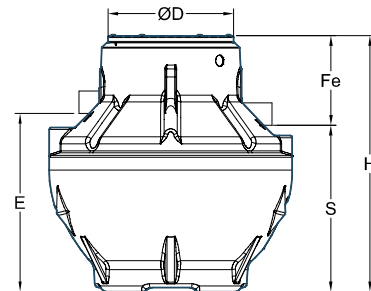
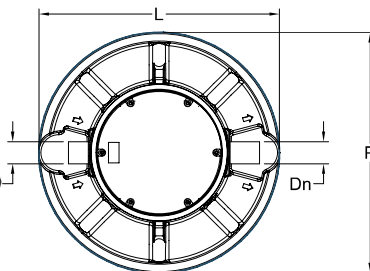

Reference	Useful Volume	P	L	H	E	S	Fe	Dn	Weight	ø D
YN02E	660	1200	1200	1230	880	825	405	110	46	585

Size in l/s, dimensions in mm, weight in kg



Cylindrical oil separator with sludge trap and coalescing filter



Class I
Discharge < 5 mg/l
Size 30 - 50 l/s

- Polyester **tank** produced by filament winding
- Polyethylene **automatic closure device** calibrated at 0,85 (other calibrations on request)
- Removable **coalescing filter**
- Cylindrical **manhole(s)** without cover

OPTIONS

- **Anchoring straps** see p. 84
- **Visual and audible alarm** see p. 83
- **Chassis speed** see p. 84
- **Polyethylene extensions** see p. 82

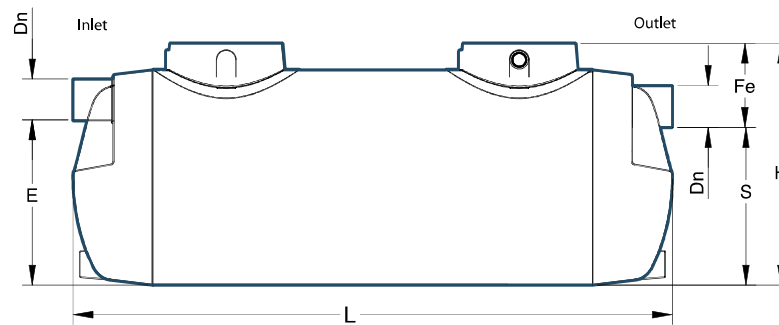
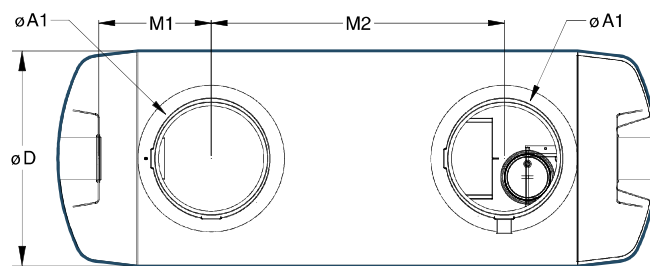
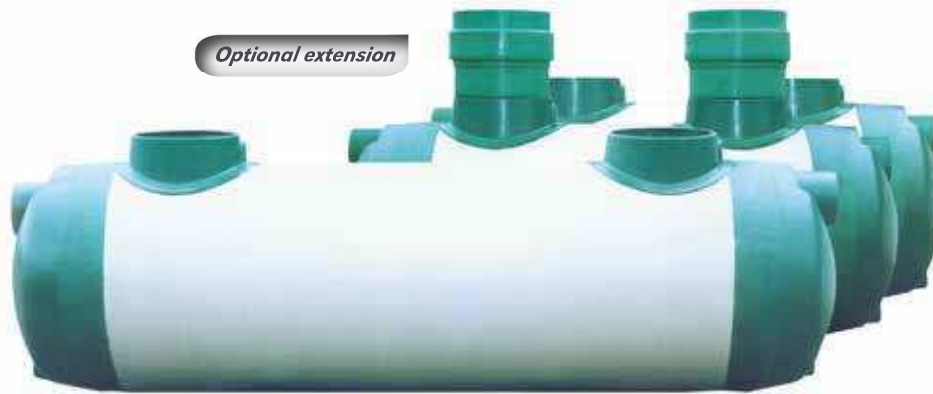

U6

Ref Range U6	Size l/s	ø D	L	Dn	E	S	Fe	H	M	N	ø A1	Weight	Volume	
													Sludge trap	Separator
U6ADA2P	30	1600	3554	200	1350	1300	516	1816	1150	1254	790	421	3000	2700
U6ADF3P	35	1600	4499	315	1240	1190	626	1816	1150	2199	790	509	3500	3150
U6AEA3P	40	1600	5093	315	1240	1190	626	1816	1150	2792	790	556	4000	3600
U6AEF3P	45	1600	5686	315	1240	1190	626	1816	1150	3386	790	605	4500	4050
U6AFA3P	50	1600	6280	315	1240	1190	626	1816	1150	3980	790	659	5000	4500

For upper sizes, please ask our design office
Dimensions are given in mm, weight in kg, volume in litres



Cylindrical oil separator with sludge trap and coalescing filter



Class I
Discharge < 5 mg/l
Size 30 - 50 l/s

- Steel **tank** with hoisting rings.
- **Bi-component coating** based on polyamid adduct/epoxy resins.
- Cylindrical **manhole(s)** without cover
- Polyethylene **automatic closure device** calibrated at 0,85 (other calibrations on request)
- **Removable coalescing filter**

OPTIONS

- **Visual and audible alarm** see p. 83
- **Anchoring turnbuckles** see p. 84
- **Chassis speed** see p. 84

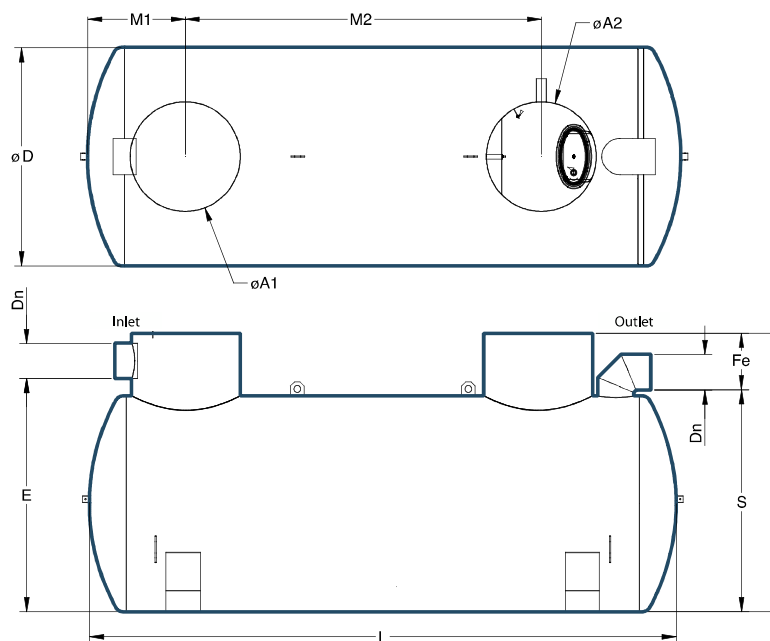

U4

Ref Range U4	Size l/s	$\varnothing D$	L	Dn	E	S	Fe	H	M1	M2	$\varnothing A1$	$\varnothing A2$	Weight	Volume	
														Sludge trap	Separator
U4ADA2A	30	1600	3547	200	1703	1653	347	2000	698	1902	750	750	726	3000	2700
U4ADF3A	35	1600	4047	300	1723	1653	467	2120	698	2187	750	950	841	3500	3150
U4AEA3A	40	1600	4047	300	1723	1653	467	2120	698	2187	750	950	841	4000	3600
U4AEF3A	45	1600	4547	300	1723	1653	467	2120	698	2687	750	950	900	4500	4050
U4AFA3A	50	1600	5047	300	1723	1653	467	2120	698	3187	750	950	988	5000	4500

For upper sizes, please ask our design office
Dimensions are given in mm, weight in kg, volume in litres



Cylindrical oil separator with sludge trap, coalescing filter & by-pass



Class I
Discharge < 5 mg/l
Size 30 - 50 l/s

- Polyester **tank** produced by filament winding
- Polyethylene **automatic closure device** calibrated at 0,85 (other calibrations on request)
- **Removable coalescing filter**
- **Cylindrical manhole(s)** without cover

OPTIONS

- **Anchoring straps** see p. 84
- **Visual and audible alarm** see p. 83
- **Chassis speed** see p. 84
- **Polyethylene extensions** see p. 82

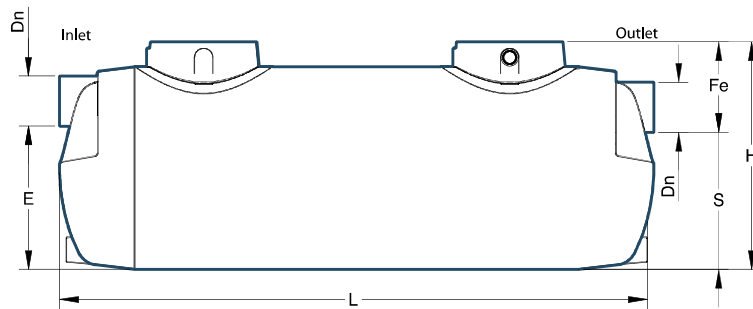
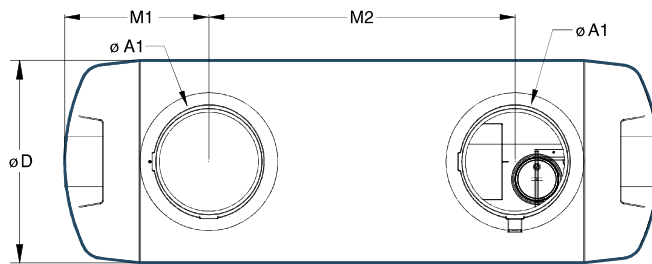

W6

Ref Range W6	Size l/s	ϕD	L	Dn	E	S	Fe	H	M1	M2	$\phi A1$	Weight	Volume	
													Sludge trap	Separator
W6ADA4P	30	1600	4105	400	1153	1103	713	1816	1150	1805	790	549	3000	2700
W6ADF4P	35	1600	4742	400	1153	1103	713	1816	1150	2442	790	607	3500	3150
W6AEA4P	40	1600	5380	400	1153	1103	713	1816	1150	3080	790	667	4000	3600
W6AEF4P	45	1600	6017	400	1153	1103	713	1816	1150	3717	790	727	4500	4050
W6AFA5P	50	1600	7206	500	1080	1030	786	1816	1150	4906	790	812	5000	4500

For upper sizes, please ask our design office
Dimensions are given in mm, weight in kg, volume in litres



Cylindrical oil separator with sludge trap, coalescing filter & by-pass



Class I
Discharge < 5 mg/l
Size 30 - 50 l/s

- Steel **tank** with hoisting rings.
- **Bi-component coating** based on polyamid adduct/epoxy resins.
- Cylindrical manhole(s) without cover
- Polyethylene **automatic closure device** calibrated at 0,85 (other calibrations on request)
- **Screening**
- **Removable coalescing filter**
- Cylindrical **manholes** without cover

OPTIONS

- **Visual and audible alarm** see p. 83
- **Anchoring turnbuckles** see p. 84
- **Chassis speed** see p. 84

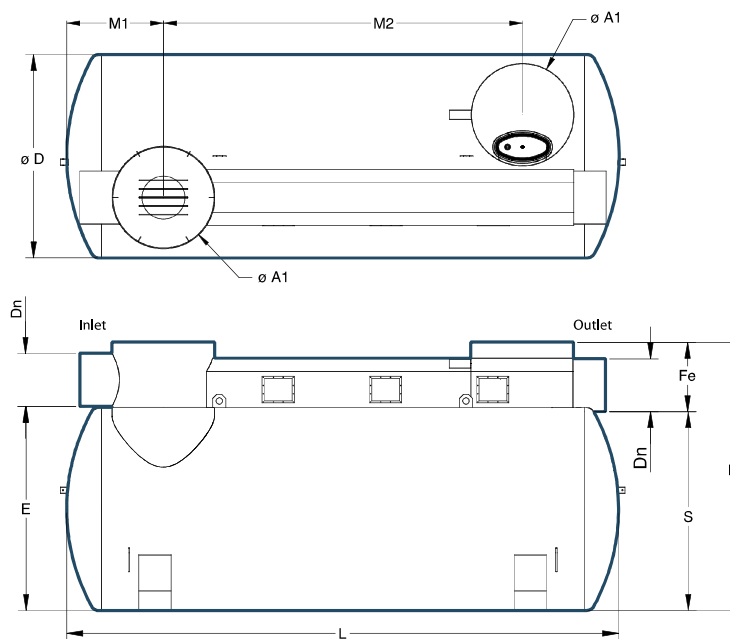

Ref Range Y1	Size l/s	$\varnothing D$	L	Dn	E	S	Fe	H	M1	M2	$\varnothing A1$	Weight	Volume	
													Sludge trap	Separator
Y1ADA4A	30	1600	3047	400	1623	1573	627	2200	801	1444	850	810	3000	2700
Y1ADF4A	35	1600	3547	400	1623	1573	627	2200	801	1944	850	917	3500	3150
Y1AEA4A	40	1600	4047	400	1623	1573	627	2200	801	2444	850	990	4000	3600
Y1AEF4A	45	1600	4547	400	1623	1573	627	2200	801	2544	850	1063	4500	4050
Y1AFA5A	50	1900	3645	500	1913	1863	647	2510	900	1844	950	1128	5000	4500

For upper sizes, please ask our design office
Dimensions are given in mm, weight in kg, volume in litres